

# JAYCO FOLD-DOWN CAMPERS

Founded in 1968

1992 Edition



Jay Series 1006 Model with Carry-out Stove and Table



Jay Series 1006, Side Dinette Model



Jay Series 806 Model

Let the fun begin! A Jayco Jay Series fold-down is your ticket to a *world* of family good times.

It'll go just about anywhere you want it to — on any kind of outing: fishing trips ... summer vacations ... weekend getaways ... you name it. It's a genuine "Freedom Machine!"

It'll save you money on transportation, hotels, and restaurants; save you the hassle of making reservations as well.

Of course, the savings begin the moment you buy a Jay Series fold-down. They're among the most economical campers on the market today. And that makes them the perfect way to go!

Once you get where you're going, you'll love the way a Jay Series fold-down sets up. Jayco's exclusive, patented roof-lifter system makes it fast and easy.\* Even a child can do it!

And at campsite — that's where you'll discover the Jay Series fold-down's real value. It offers you the comforts of an RV with the easy informality of tent living: You're thoroughly pampered; yet free to experience the best of nature.

A few of the Jay Series' more notable features include:

- A big, roomy, built-in ice box — beats a cooler any day! Has Styrofoam insulation to keep ice longer; a door on the front side — not the top — so you have more usable countertop space; convenient shelving, even inside the door; a self-draining feature eliminating the need to empty out melted ice.
- A carry-out stove in every model (Design Series™, too) lets you cook where it's most convenient — indoors or out. Built-in wind deflectors guard the flame.
- A galley that stows away on top of the dinette — not in the aisle as in many competitor's fold-downs. With Jayco, you can use the aisle space for extra storage when you're on the road.

Continued on Page 5

\*U.S. Patent No. 3,495,866.



*Jay Series 806 Model Hitched to a Jayco Mini Van*



Jay Series 1006 Model  
with Deluxe Option Package



Carry-out Stove



Positive-lock Catches



Large built-in ice box

### DELUXE OPTION PACKAGE

All these popular features can be yours — for one low package price!

- End bunk privacy drapes
- Attractive bed skirts
- Fashionable valances
- A clothes-hanging bar
- 4"-thick cushions (3"-thick cushions are standard)
- A bracket on one exterior wall that allows the dinette table to be used outside with an adjustable leg
- A patio light
- A convenient outside door holder
- An outside 110-volt receptacle.

Continued from Page 3

In most units, the galley simply flips over onto the dinette. This arrangement has one other benefit: You can still get into the ice box and the cabinets when a Jayco fold-down is closed up for travel — without having to crank up the roof!

- Positive-lock catches on all doors and drawers to keep them securely shut during travel. Stored items remain stored, not spilled out on the floor when you arrive at campsite.
- The smoothest, simplest-operating roof-lifter system on the market (see Page 8 and the back cover for details)!
- A Lifetime Limited Lifter-System Warranty (talk to your Jayco dealer)!
- Independent torsion-axle suspension for a smooth, stable ride (see Page 8).
- Hard-wearing, good-looking, heavy-duty duck canvas (see Page 8).
- A domed roof for extra strength and proper water runoff (see page 8).
- Comfortable, accommodating end bunk — up to almost seven feet wide in some models!
- Easy-to-clean vinyl-backed seat cushion — use the vinyl side when the kids come in wet or dirty.
- A 14"x14" roof vent (big enough to accept an optional air conditioner).
- Tinted windows with curtains to cut heat and glare, increase privacy.
- Lots of storage space — including more drawers than most competitors offer.
- A full-width, welded bumper to increase strength, improve appearance.
- A spare tire mount with spare lug bolts for added peace of mind.
- Two or four self-storing stabilizing jack (depending on the model) — can't be left behind.
- High-capacity tires to hug the road better and let you carry more cargo.
- An ABS stoneguard at the front for added protection.
- Eleven clearance lights for safety.
- Convenient backup lights — also for safety.



*Designer Series King 6, Side Dinette Model*



*Designer Series Cardinal SD Model*

# DESIGNER SERIES™



ABS Front End & Bottle Cover



Lockable Outside Storage

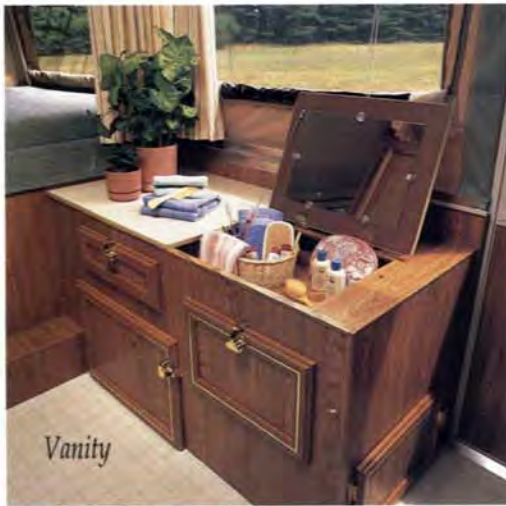

Vanity



Wardrobe



Overhead Cabinet



Designer Series Cardinal, Side Dinette Model

This is our high-line camping trailer: a fold-down for those who want the ultimate in camping comfort.

It has all the advantages of a Jayco Jay Series™ fold-down ... and then some!

Consider its styling, for instance. The Designer Series is sleek, clean, and contemporary; an ideal complement to any outdoor setting.

Inside, you'll find the kind of amenities that *really* bring campsite living to life. Experienced campers agree that the Designer Series is the best-equipped fold-down on the market — *bar none!*

It's features like these — in addition to those the Jay Series offers — that set the Designer Series apart:

- High-style cabinet doors and drawers — framed for extra touch of elegance.
- A vanity in most models — for more convenient campsite grooming.
- A handy overhead cabinet in most models.
- 80"-wide end bunks for supreme sleeping comfort.
- A 40" or 43" tall wardrobe for hanging clothes full-length.
- Attractive valances throughout unit.
- End-bunk privacy curtains.
- Plush, 4"-thick Dacron-padded cushions.
- Three outside storage compartments — all lockable.
  - A smooth fiberglass skin — for the most popular exterior look going! It's tough, too.
  - Extra-durable ABS front and rear caps.
  - An ABS bottle cover for extra protection and a neater appearance.
- Four self-storing stabilizer jacks on all models.
- A convenient carry-out table.
- A patio light.
- A 110-volt outside receptacle.
- An adjustable mirror on the entrance door.
- A magazine rack.

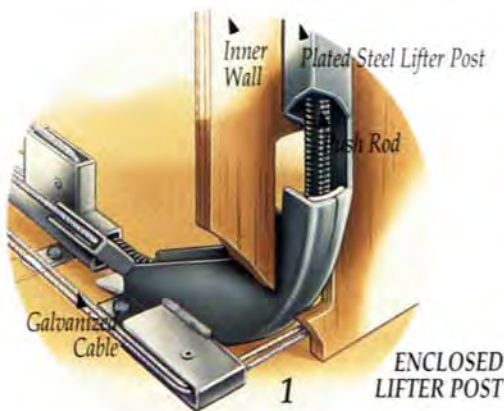

**ENCLOSED LIFTER POST**

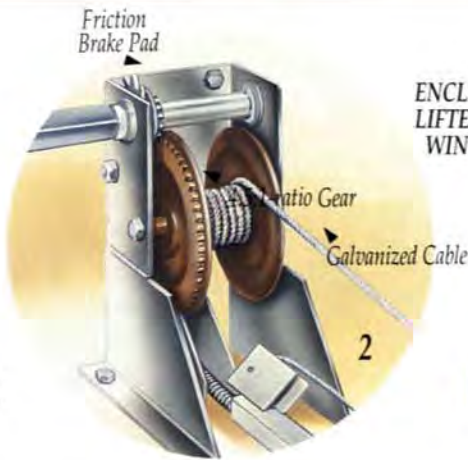

**ENCLOSED LIFTER-SYSTEM WINCH**

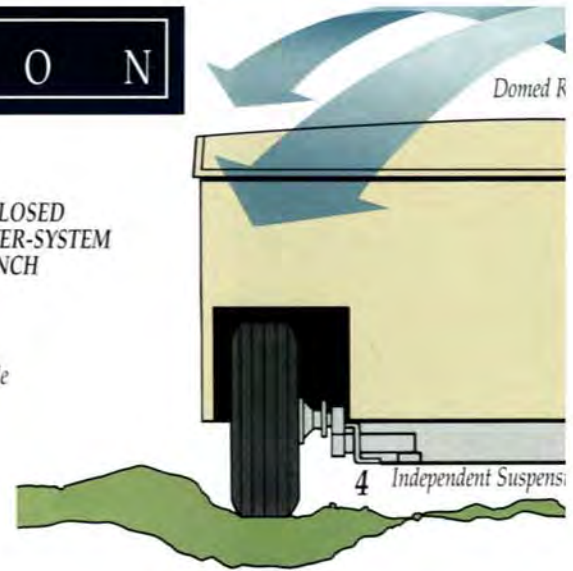

**LIFTER SYSTEM:** Fully enclosed above the floor, where it's protected from stones, dirt, tar, and the elements. Backed by Jayco's own Lifetime Limited Warranty to the original owner.\*

**1** No holes in floor for cable access, since cables are above floor (which means bugs and rodents have no access, either). **2** Automatic brake on winch prevents the roof from free-falling. You can stop cranking at any time and the roof will remain at the position where you stopped. An excellent safety feature. **3** Strong push rods push up the lifter posts to raise the roof. There are no cables in the posts, so there's no danger of cables snagging, tangling, or breaking to foul up the system. Jayco's entire lifter system uses only 45 feet of cable, as opposed to around 75 feet in most other brands.

**INDEPENDENT TORSION-AXLE SUSPENSION:** Creates a smooth, secure ride. Puts less strain on the hitch and tow vehicle, too, which saves the tow vehicle's frame, suspension, and running gear from excessive wear. Overall, towing a Jayco fold-down is one of the smoothest, safest, and most pleasurable towing experiences you can have. **4** Wide-track axle lends more stability — limits trailer "hop". **5** Higher grade tires handle greater load capacities, last longer, and help smooth the ride.

**CANVAS TENT:** **6** Heavy-duty duck canvas (not shown), field-proven over years of use. More durable than synthetic fabrics since it does not scuff. Also is highly flame-retardant and waterproof. Double stitching makes for long seam life. If repairs ever become necessary, they're easy to make.

**ROOF:** **7** Fully laminated and domed in all directions to add strength and allow proper water runoff. Most other fold-down roofs are nearly flat or have a simple arc instead of a dome. Comes with a five-year limited warranty.\*

**8** Standard 14" x 14" roof vent (not shown) will accept an air conditioner without modification. No extra bracing is required, either.

**OTHER FEATURES:** **9** Wheel wells of galvanized steel that won't rust or crack. **10** Smooth, durable fiberglass exterior sidewalls (on Designer Series only. Jay Series has a sturdy .024 aluminum exterior backed with wood for additional strength). **11** A 4" C-channel frame with bracing in key areas. Warranted for five years.\* **12** Nylon rollers in end walls to help bunks pull out easily.

**13** Floor and end bunks of fully undercoated 1/2" - 5/8" exterior-grade plywood. Floor warranted for five years.\* **14** Nylon bushings in lifter posts for even smoother operation and less wear.



**15** Aluminum ceiling in laminated roof to resist mildew and permit easy cleaning.

\* See your Jayco dealer for complete warranty details.



# O P T I O N S

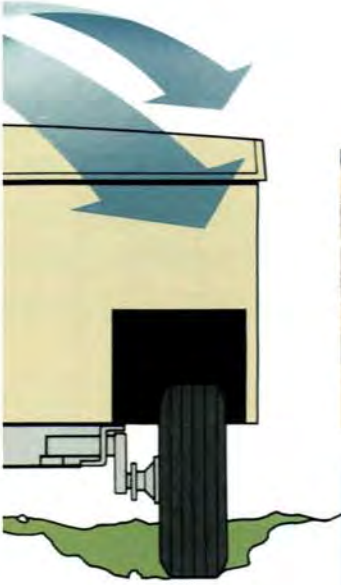

Boat Rack



Cargo Rack



Bike Rack



Screen Room



Jayco's Exclusive Canopy



Canvas Add-a-Room



Shower/Toilet

Our fold-downs offer standard features that greatly simplify campsite living — for everyone. But they're also available with any of a wide range of options; practical, comfort-enhancing features that express highly individual preferences. We're sure to have something just right for *you!*

A full listing of the options we offer is provided in the specifications chart on pages 10-11 of this brochure.

Highlights include:

- A boat rack capable of holding boats of up to 200 pounds.
- A roof-mounted cargo rack.
- A bike rack designed to hold one or two bicycles.
- A Jayco canopy — manufactured by Jayco exclusively for Jayco fold-down color-coordinated to both series, self-standing, with spring-loaded pole that eliminate the need for support ropes.
- A screen room that not only provides extra living space, but lets the fresh air in while keeping bugs out.
- A canvas add-a-room that nearly doubles your living space — and keep it private. A zippered flap closes off the entrance door. Interior roll-down shades cover the screened windows.
- A shower unit (for select models) — with a toilet, hot water heater, holdin tanks, and a privacy drape.
- A retractable entrance step for easier entrance and exit.
- A self-storing entrance step.
- A completely removable entrance step



Entrance Step

**1992 FOLD-DOWN SPECIFICATIONS**

SPECIFICATIONS	DESIGNER SERIES				JAY SERIES				
	Thrush	King 6 SD	Cardinal	Cardinal SD	806	806 SD	1006	1008 SG	1206
Travel length	14'9"	16'10"	18'10"	18'10"	12'8"	12'8"	14'8"	14'8"	16'10"
Campsite length	21'2"	22'2"	24'2"	24'2"	17'4"	17'4"	21'6"	21'6"	21'6"
Approximate travel height	55"	55-3/4"	55-3/4"	55-3/4"	49-1/2"	49-1/2"	51-1/2"	51-1/2"	55-3/4"
Interior campsite height	77"	77"	77"	77"	77"	77"	77"	77"	77"
Exterior width	85"	85"	85"	85"	81"	81"	81"	81"	85"
Approximate dry weight with standard equipment (lbs.)	1585	1910	2175	2220	995	995	1340	1320	1615
Approximate axle weight (lbs.)	1425	1720	1975	1995	885	875	1185	1165	1440
Cargo capacity (lbs.)	780	685	1175	1070	775	775	800	820	765
Approximate dry hitch weight (lbs.)	160	190	200	225	110	120	155	155	175
C-channel steel frame size	4"	4"	4"	4"	3"	3"	3"	3"	4"

EXTERIOR FEATURES									
Self-storing stabilizer jacks	4	4	4	4	2 (Opt 4)	2 (Opt 4)	4	4	4
Tire size	20 x 8:00 x 10	20 x 8:00 x 10	20 x 8:00 x 10	20 x 8:00 x 10	5.70x8	5.70x8	5.30x12	5.30x12	20x8:00
Designer wheel	S	S	S	S	N/A	N/A	S	S	S
Chrome center hubcap	S	S	S	S	N/A	N/A	N/A	N/A	N/A
Outside storage trunk	S	S	S	S	N/A	N/A	O	O	O
Two lockable trunk compartments in rear	S	S	S	S	N/A	N/A	N/A	N/A	N/A
12-volt patio light	S	S	S	S	O	O	O	O	O
Back-up lights	S	S	S	S	S	S	S	S	S
25' power cord	S	S	S	S	S	S	S	S	S
Outside receptacle	S	S	S	S	O	O	O	O	O
Safety recessed spare tire mount	S	S	S	S	N/A	N/A	N/A	N/A	N/A
Flush spare tire mount	N/A	N/A	N/A	N/A	S	S	S	S	S
Hydraulic surge brakes with breakaway chain	O	S	S	S	O	O	O	O	S
20# LP gas tank with regulator	S	S	S	S	O	O	S	S	S
Outside table bracket	S	S	S	S	O	O	O	O	O
Gas bottle cover	S	S	S	S	O	O	O	O	O
Permanently attached, zippered duck canvas (10.10 oz.)	S	S	S	S	S	S	S	S	S
Smoked side windows/screens	S	S	S	S	S	S	S	S	S
Fiberglass exterior	S	S	S	S	N/A	N/A	N/A	N/A	N/A
Aluminum exterior	N/A	N/A	N/A	N/A	S	S	S	S	S

GALLEY FEATURES									
Fresh water tank (gal.)	11	20	20	20	Opt 5	Opt 5	5	5	20
City water hook-up	S	S	S	S	O	O	S	S	S
Galley & porcelain sink	S	S	S	S	N/A	N/A	N/A	N/A	N/A
Galley & stainless steel sink	N/A	N/A	N/A	N/A	O	O	S	S	S
Removable range	S	S	S	S	Opt Range	Opt Range	S	S	S
Ice chest (lbs.)	75	75	75	N/A	35	35	35	35	75
LP gas/110V/12V electric refrigerator (1.7 cu. ft.)	O	O	O	S	O	N/A	O	O	O
Overhead cabinet with light underneath	N/A	S	S	S	N/A	N/A	N/A	N/A	C
Wardrobe	S	S	S	S	N/A	N/A	N/A	O	O
12-volt electric system with converter (amps)	10	10	10	10	Opt 6	Opt 6	6	6	6

INTERIOR FEATURES									
Foam cushion & backs with zippers (thickness)	4"	4"	4"	4"	3"(Opt 4")	3"(Opt 4")	3"(Opt 4")	3"(Opt 4")	3"(O
Additional 1" Dacron padding in cushions	S	S	S	S	N/A	N/A	N/A	N/A	N/A
12-volt interior light(s) (No.)	2	4	4	4	1	1	2	2	2
14" x 14" roof vent	S	S	S	S	S	S	S	S	S
Convenient adjustable mirror on entrance door	S	S	S	S	N/A	N/A	N/A	N/A	N/A
Positive drawer & door catches	S	S	S	S	S	S	S	S	S
Window curtains	S	S	S	S	S	S	S	S	S
Bunk-end privacy curtains	S	S	S	S	O	O	O	O	O

OPTIONAL FEATURES									
Recirculating toilet	N/A	N/A	O	N/A	N/A	N/A	N/A	N/A	N/A
Portable toilet	O	O	O	O	O	O	O	O	O
Water repellent 7-oz. Evolution 3 tent fabric	O	O	O	O	O	O	O	O	O
LP gas/12V electric refrigerator (1.8 cu. ft.)	O	O	O	N/A	O	O	O	O	O
LP gas/110V/12V electric refrigerator (1.7 cu. ft.)	O	O	O	S	O	N/A	O	O	O
LP gas/110V electric refrigerator (2.9 cu. ft.)	N/A	O	O	O	N/A	N/A	N/A	N/A	C
Awning	10'	12'	14'	14'	8'	8'	10'	10'	12'
Continental spare tire cover	O	O	O	O	N/A	N/A	N/A	N/A	N/A
10 gallon water tank	N/A	N/A	N/A	N/A	O	O	O	O	N/A
Extra table	N/A	O	N/A	O	N/A	N/A	N/A	O	C
Electric brakes	O	N/A	N/A	N/A	O	O	O	O	N/A
Interior Deluxe Package (includes privacy drape, 4" cushions, patio light, outside table bracket & adjustable table leg, door holder, outside recept, valance, bed skirt, clothes bar, cushion back rest (most units))	N/A	N/A	N/A	N/A	O	O	O	O	C
Plumbing Deluxe Package (includes water heater, demand water pump, hot & cold mixing faucet, 20-amp converter (double sink in 1406 and Cardinals only))	N/A	O	O	O	N/A	N/A	N/A	N/A	C
Bathroom (includes water heater, demand water pump, hot & cold mixing faucet, 20-amp converter, shower, cassette porta-potti, holding tank, shower curtain, dressing area curtain (double sink in 1406 and Cardinals only))	N/A	O	N/A	O	N/A	N/A	N/A	N/A	C
Kitchen Console (includes LP gas tank with regulator, stove, water tank, sink, 2-way hand pump, city water hook-up, converter)	N/A	N/A	N/A	N/A	O	O	N/A	N/A	N/A
4-burner LP gas range with oven	N/A	N/A	O	N/A	N/A	N/A	N/A	N/A	N/A

# Designer Series™

# Jay Series™

1208	1406
16'10"	18'10"
21'8"	23'8"
55-3/4"	55-3/4"
77"	77"
85"	85"
1600	1985
1425	1785
780	1175
175	200
4"	4"

4	4
20x8:00x10	20x8:00x10
S	S
N/A	N/A
O	S
N/A	N/A
O	O
S	S
S	S
O	O
N/A	N/A
S	S
S	S
O	O
O	O
S	S
S	S
N/A	N/A
S	S

11	20
S	S
N/A	N/A
S	S
S	S
75	75
O	O
O	O
O	O
6	10

3"(Opt 4")	3"(Opt 4")
N/A	N/A
2	3
S	S
N/A	N/A
S	S
S	S
O	O

N/A	N/A
O	O
O	O
O	O
O	O
12'	14'
N/A	N/A
N/A	N/A
O	O
N/A	N/A
O	O
N/A	N/A
N/A	N/A



**Thrush**

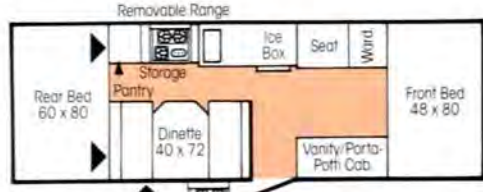

**King 6 SD**

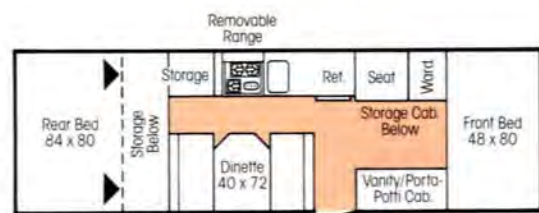

**Cardinal SD**

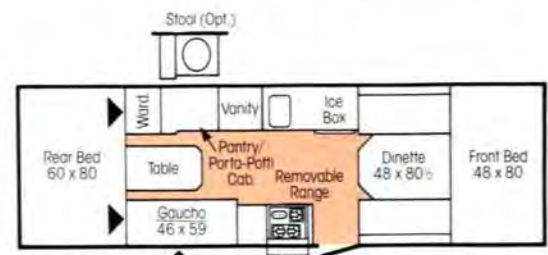

**Cardinal**

## Other Optional Features Available on the Jay Series and Designer Series

- Canopy/screen enclosure
- Jayco Add-a-Room enclosure
- Dual 20# LP gas tank with regulator
- Furnace (12,000 or 16,000 BTU input, Piezo Ign.)
- Furnace (12,000 or 16,000 BTU input, Electronic Ign.)
- "Safety Step" (removable)
- "Step-N-Stor" (self-storing)
- Mark II step (self-storing)
- Air conditioner prep.
- Boat rack
- Luggage rack
- Bike rack
- Battery
- Spare tire
- Vinyl spare tire cover

▲ Outside Storage Compartment

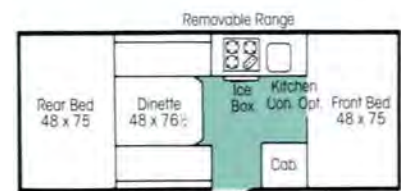

**806**

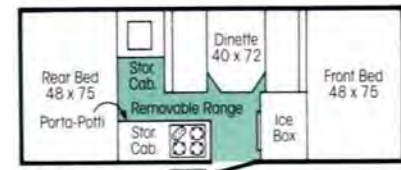

**806 SD**

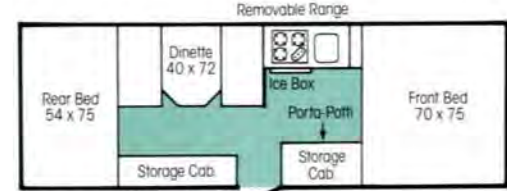

**1006**

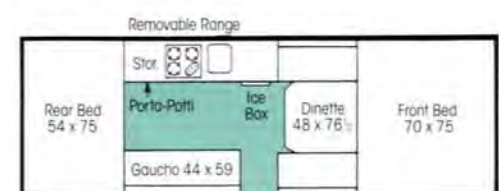

**1008 SG**

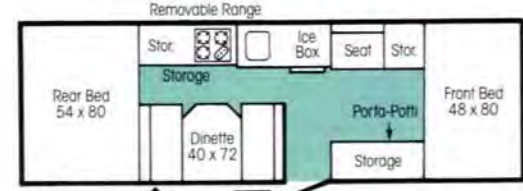

**1206**

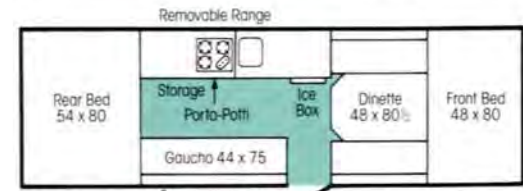

**1208**



**1406**



Whether you own a Jay Series or a Designer Series fold-down, the same fast and easy setup applies. You spend less time making camp; more time enjoying it!

- 1 Position the permanently installed stabilizing jacks, but don't level the camper until it's completely set up. The jacks swing into place easily.
- 2 Unlatch the roof. Then open the hatch at the front of the camper, insert the crank handle in the winch, and turn. As you do, the roof will rise almost effortlessly. The crank is positioned at a height that makes operation comfortable.
- 3 Unlike some fold-downs, there are no awkward outside arms to contend with. And a built-in brake mechanism eliminates the danger of free-fall. That means you can stop cranking at any time and the roof will stay up.
- 4 Once the roof is up, pull out the end bunks and position the canvas. Rigid steel tracks make the end bunks slide easily into

place. Insert the support bars under the end bunks to give them extra strength and stability.

- 5 Now go inside the camper and unfold the upper screen door from the ceiling.
- 6 Attach the upper door to the lower door with Jayco's simple, ingenious double hinge, and press the canvas into the groove around the door frame. This interlocking groove system holds the canvas in place much more securely than the Velcro fasteners used on some other fold-downs.
- 7 Swing the galley into place and insert the canvas support bars in the end bunks.
- 8 Then go outside and attach the canvas to the end bunks by means of the bungee cords (they compensate for inevitable canvas shrinkage over time). Stabilize the camper by adjusting the permanently installed stabilizing jacks. That's all there is to it! You're ready to enjoy great campsite living in no time!

For Further Information and Prices, See Your Dealer:



**JAFARI INTERNATIONAL TRAVEL CLUB**

We cordially invite you, as we do all Jayco owners, to join the Jayco Jafari International Travel Club. Ask your dealer about the Jafari chapter, or "flight", as it's called, in your area. Or write Jayco direct.

**LIFTER SYSTEM LIFETIME LIMITED WARRANTY**

Jayco, Inc., warrants to the original purchaser of every Jayco fold-down camping trailer that the lifter system is free from substantial defects in materials and workmanship for the lifetime of the fold-down camping trailer. A copy of this limited warranty is available for inspection upon request from your Jayco dealer.

**LIMITED WARRANTY**

Jayco, Inc., warrants to the original purchaser of every Jayco fold-down camping trailer that the roof, floor, and frame are free from substantial defects in materials and workmanship for three (3) years on labor and five (5) years on parts from the date of purchase under normal use and service. Other components are warranted for twelve (12) months for parts and labor from the date of purchase. This warranty does not apply to any defect in the aesthetics or physical appearance of the unit, nor to normal deterioration of the soft trim and appearance items due to wear and exposure. A copy of this limited warranty is available for inspection upon request from your Jayco dealer. Separate manufacturers' warranties cover various components used in Jayco products.

**PLEASE NOTE:**

All illustrations and specifications contained in this brochure are based on the latest product information available at the time of publication approval. Because Jayco continually seeks to improve its products, and also because of changes in the availability of various components, Jayco reserves the right to make changes at any time in prices, colors, materials, equipment, specifications, and models, and to discontinue models without notice or obligation. Components or parts may have been manufactured at times other than the model year indicated. Also, pictures in this brochure may show optional equipment available at extra cost. Recreation vehicles built for sale in Canada may differ somewhat to conform to Canadian codes. See your dealer for details.



**Jayco**<sup>®</sup>

At Home in Your World

Jayco, Inc. • P.O. Box 460  
Middlebury, IN 46540

For its ongoing leadership in protecting the environment, Jayco, Inc., has received the "State of Indiana Governor's Award for Excellence in Recycling".