

# 101

## Customer Driven Features



**VALOR**, Courageously  
bold and determined  
MULTIFUNCTIONAL HAULERS



*Obsessed with providing  
the best RV ownership  
experience!*

# 101 PRODUCT FEATURES MAKING VALOR FIFTH WHEELS THE BEST VALUE FOR YOUR INVESTMENT



**Our Goal** is to provide the absolute best customer RV ownership experience.

As an independent and owner operated company obsessed with providing the best ownership experience our team is empowered to do things differently and do the right thing.

With all of us going the extra mile to do things better, Alliance RV provides superior products that look better, perform better, and last longer, all while providing you the best ownership experience.

## CAMP READY PERFORMANCE AUDIT

We are going the extra mile to help ensure your Alliance RV is “Camp Ready”. With holding tanks full, Alliance RVs hits the open road for a 15-minute “shakedown”



test tow that includes bumps, turns and rapid stops. This open road test identifies any potential concerns that would have only shown up when the coach was in transit to you and your dealer. Following the test drive, we bring the coach into our dedicated Performance Audit Bay for another round of systems checks and white glove inspection. Upon a 100% successful Performance Audit, we deem the RV to truly be “Camp Ready”!

# A MEANINGFUL WARRANTY



A WARRANTY IS ONLY AS GOOD  
AS THE COMPANY THAT BACKS IT.



Every Alliance RV is generously backed with a 3-year limited structural and 1-year limited base warranty. Further, what really makes Alliance RV stand out is our willingness to communicate our guiding principle of **“Do The Right Thing”**.

We understand there is not a one size fits all solution when it comes to your warranty and service needs. Our ability to keep open lines of communication with both you and your Alliance dealer will help us find a creative service solution for your specific case. Add to this the unique service and warranty programs we have implemented for our Alliance dealers to streamline the approval process and parts delivery times... all towards the mission of getting our Alliance RV owners back on the road faster and enhancing your RV ownership experience. If you ever want to speak with one of our customer service representatives, please don't hesitate to contact us at (574) 226-0140.

**Full-time RVing won't void your Alliance RV warranty\***

Many manufacturers incorporate language that voids the warranty in the case of full time RVing.



\*Additional equipment may be necessary in certain climates or conditions for full time use.

# SOLID FOUNDATION

Next generation advanced frame technology with heavy duty Performance Running Gear.

Redesigned from the ground up, the

Benchmark Chassis features solid steel 10" I-beam main rails with a 2" torsion tube welded where the running gear attaches, drop frame storage area, flush upper deck design, reinforced goose neck area and a Rota-Flex pin box.



## SPACE SAVER UPPER DECK

Engineers were able to redesign the upper deck to be stronger, while flattening the deck to eliminate the toe breaker steps typically found in this space. Stronger design + flush upper deck = smarter chassis.



## ROTA-FLEX PIN BOX

The Rota-Flex pin box has a pivoting head with built in rubber block to reduce chucking and absorb road shock while towing.



# RUN FULL HOLDING TANKS

We know its not always possible to empty the holding tanks before hitting the road. We've all seen tanks fall out of the bottom of an RV and we have made it a priority to eliminate this from happening in an Alliance RV.



Our fresh tanks are encased in a robust steel cage. Waste tanks are molded to rest on full length steel Z rails and secured with steel straps to prevent shifting in transit.



## DROP FRONT FRAME AND TANK SIZES

Our Benchmark drop frame design raises the bar on front storage, increasing the volume of the storage compartment by over 30%.

### Class leading tank sizes:

98 Gal. Fresh  
106 Gal. Gray  
53 or 106 Gal. Black\*

\*Model specific

# RUNNING GEAR REDEFINED



We listened to RVers to determine the good, bad, and ugly from the people who actually own and frequently use RVs. Unanimously, it was clear that tire blow-outs, insufficient springs, thin shackles, and spring hanger failures was a critical area that needed to be addressed.

Building on the latest advancement in chassis design, we have strategically selected our Performance Running Gear system to address the common failures often seen at this pricepoint.

**8** 2" Torsion Tube welded to the I-beam for unbeatable strength and rigidity

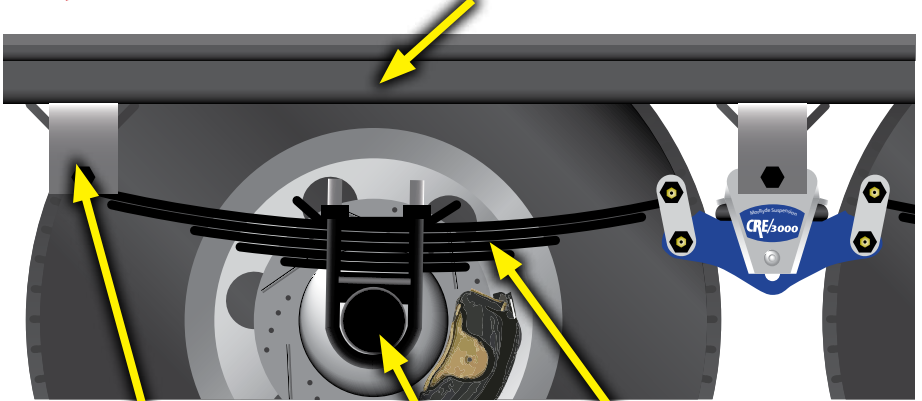

**9** Spring Hangers with V-Bracket Reinforcement



**10** Dexter Heavy Duty 4K Springs (not typical 3.5K)

**11**  Dexter 7,000 Lb. AXLES

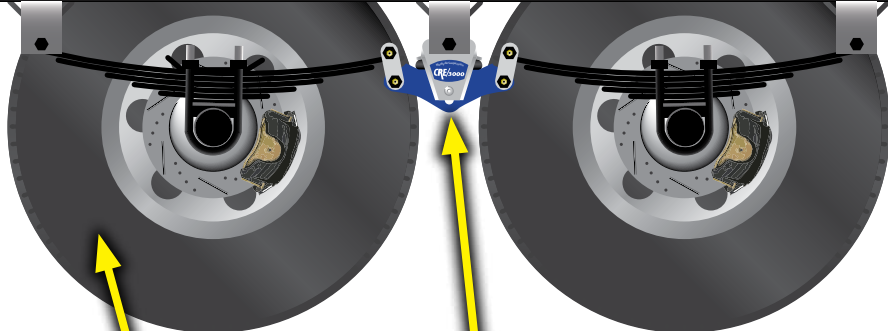

**12**  
**Super G- 4,400 Lb.  
Rated Tires**

**MorRyde CRE3000  
Suspension System**

**13**



Our 14-ply, steel belted tires are rated 320 lbs. higher than the typical G-range tires used by many competitors.

Tires are covered by Lionshead (12) month No Excuses Guarantee program and a (5) year limited warranty against manufacturers defects. See Lionshead product warranty policy for details.

**MorRyde Heavy Duty  
1/2" Thick Shackles  
and Wet Bolt Kit**

**14**



# ALL-IN-ONE UTILITY CENTER



The Alliance Utility Center brings vital connections to one convenient location for management of water hookups, coaxial connections, battery shut off, and tank pulls. Additionally there is a light for when the sun is down, a quick connect sprayer to wash up after dealing with the business end, and a 110V outlet for your convenience.

## PEX PLUMBING

Cross-linked polyethylene (PEX)

Real PEX water lines are used throughout to create a reliable and temperature resistant plumbing system. Traditional braided lines (commonly used by some manufacturers) provide an inferior fit at the connection points, making them more susceptible to water leaks.



## SHUT-OFF VALVES AT PLUMBING FIXTURES



Don't let a leaky toilet or dripping sink shut down the water supply to your whole coach. Simply shut off the dedicated valve to the toilet or sink and address the issue at your leisure.





## BONUS FRONT STORAGE

18



Additional storage up front, above the generator and battery compartment, for gear, tools and more. Alliance takes advantage of every square inch so you have the space you need for that extended stay.

## SLAM LATCH BAGGAGE DOORS

19

Slam latches and automotive bulb seals keep the baggage compartments tight, dry, and secured. Large handles for easy opening and magnetic stays make for convenient access to your gear.



## PAINTED FRONT CAP



We paint our front cap to match the sidewall color.

The automotive paint is durable and long lasting, looks fantastic, and protects the value of your investment.



## AUTOMOTIVE VINYL GRAPHICS



Valor features vinyl film graphics that are vibrant, durable and long lasting.

Our vinyl film graphics have minimal shrinkage and the ability to withstand extreme temperatures. Your exterior graphics will look great for years!

## TEXTURE EMBOSSED SKIRT



Attention to detail sets Valor apart from the rest. Our skirt metal has an attractive texture where most others are smooth and lack style.



## DUAL 30 POUND LP

23



Extend your RV stay a little longer with 60 pounds of LP in two 30 pound tanks located on both sides of the coach for even weight distribution and equipped with an auto changeover valve.



## SIX POINT AUTO LEVEL

24



Six point hydraulic auto leveling is Faster, Stronger, Quieter, and makes short work of leveling your coach so you can get to relaxing. We mount the control panel in a compartment on the off-door side by the front jacks.

## OVERSIZED AWNINGS



Alliance maximizes the usability of your patio with huge awnings made of dark material that blocks more sun.

These awning arms don't have the traditional wingnut adjustment. A friction hinge and gas strut provide easy, one handed adjustments and act as a shock absorber should a wind gust catch the awning.

Includes a manual override in case of no power.



## AWNING PATIO LED LIGHTING



Enjoy your patio lights with or without the awning out.

Our patio awning LED lighting is mounted to the sidewall so you don't have to run your awning out all the way to reveal the lights.

## OFF DOOR SIDE SECURITY LIGHT



Added security and peace of mind being able to see at night on the off door side of your unit. The off door side security light is on an independent switch.



Polyvinylchloride

# PVC

**SEAMLESS  
ROOF MATERIAL**

- ZERO MAINTENANCE
- EASILY REPAIRABLE
- EXTREMELY DURABLE
- REFLECTIVE SURFACE

## PVC ROOF



We protect your investment from the top down with a seamless PVC roof material that is more puncture resistant than the TPO used by many others. PVC is ultra bright white and more solar reflective to help keep your unit cool. Last but not least, in the unlikely event of a roof tear, it can be repaired simply with a patch of the same PVC material and PVC cement from your local hardware store.

## HEATED AND ENCLOSED UNDERBELLY WITH TANK PADS



Extend your RVing season into the cooler months with a heated and enclosed underbelly.

12-volt tank heat pads are standard on all fresh, gray and black tanks.



# DOUBLE INSULATED ROOF FIBERGLASS AND REFLECTIVE



When it comes to insulation we install the best of both schools of thought with traditional fiberglass batten insulation and a seamless layer of reflective material for maximum efficiency in hot and cold climates.



## LAMINATED WALLS

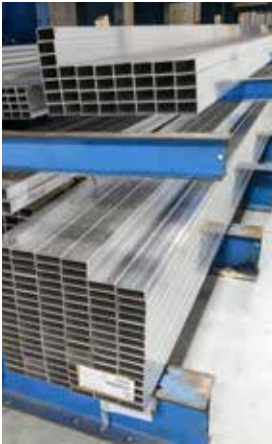

A reliable sidewall begins with a durable frame made of high grade aluminum that is professionally welded and reinforced at stress points. Block foam insulation fills all the voids in the framework and it is all sandwiched between an AZDEL composite substrate and fiberglass on the outside and interior wallboard on the inside. The entire wall assembly is laminated and cured to perfection for the ultimate sidewall.



Alliance sidewalls, slide face and end walls are all laminated.

- 50% Lighter
- No Rot, Mold, Warping, or Delamination
- 2X Insulation Value
- Odorless, NO Formaldehyde
- Quieter RVs
- No Impact to the Rainforest
- Unaffected by Humidity and Temperature Changes
- Long Life
- Made in USA



# HIGH GLOSS FIBERGLASS EXTERIOR



Just as the sun was setting over the dune it is a spectacular sight to see the setting sun reflect in the high gloss fiberglass on the Valor. This high gloss will last for years and keep your coach looking spectacular for many sunsets to come.



## MS POLYMER SEALANT



Traditionally RVs are sealed with silicone. Silicone is a fine sealant but it has weaknesses. Nothing sticks to silicone, not even more silicone. That said, when it is time for maintenance of your seals you have to dig out and remove all the old silicone getting down to clean surfaces before resealing your RV. Silicone also shrinks over time leaving your RV vulnerable to leaking that can cause expensive water damage.

Alliance combats these problems by using a MS Polymer sealant. MS Polymer is completely solvent free and is composed of 100% solids that will not shrink. It dries to the touch quickly and cures in wet, dry, hot and cold conditions for a superior seal every time. Best of all, MS Polymer adheres to itself making seal maintenance much easier.



## PATIO SIDE SPRAY PORT

34

A convenient quick connect coil hose sprayer is included that can hook up on the patio side of the coach for rinsing off feet, pets, and even grandkids before entering. A second spray port is located on the off-door side in the utility center.



The hose stores neatly in the compartment and is resistant to tangles and kinks.



The coil hose stretches approximately eight feet.

## PATIO SIDE LP QUICK CONNECT

35

No need for all the little portable LP cylinders when you have 60 pounds on-board. With a patio side LP hookup you can conveniently use your camp grill or patio heater to dine and entertain.





## SOLID STEP ENTRY

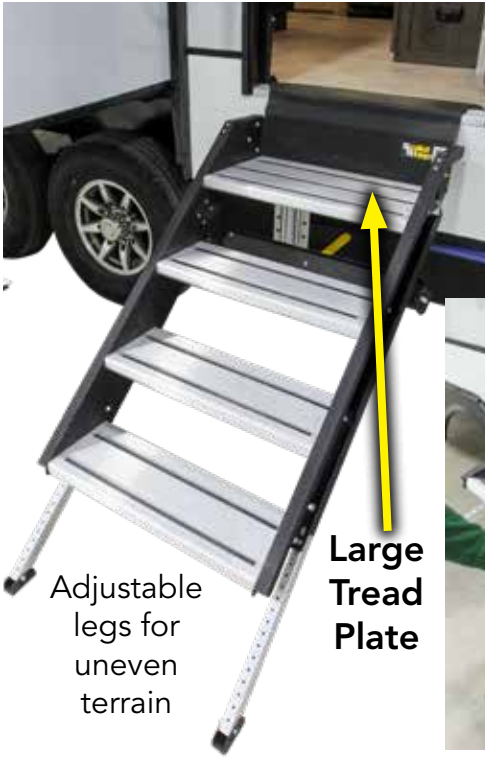

Adjustable  
legs for  
uneven  
terrain

Large  
Tread  
Plate

Solid Step entry is solid unlike traditional fold-away steps that are flimsy and bouncy.

One finger is all it takes to lift the solid steps up to stow away for travel



## UNDER-FRAME PATIO LIGHTING



Patio side under-frame LED lighting adds a nice touch to your patio experience, lighting the ground up for your enjoyment and safety. Not to mention, it just looks cool!

38

## TRIPLE A/C STANDARD

**40,500 BTU**  
Of Cooling Power



**50% MORE EFFECTIVE**

Triple 13,500 BTU, ultra quiet, independently controlled direct flow A/C units maximize cooling capacity.

## ULTRA QUIET DUCTLESS DESIGN <sup>39</sup>



Ducts reduce cooling efficiency. Our ductless A/Cs deliver 100% of the cold air produced by the A/C units directly into the RV (with the exception of the third A/C where there are walls in the way and we duct the bare minimum length to cool the bathroom.)

Our system is very quiet, using the latest Mach NDQ series

Non Ducted Quiet air conditioners.

Operating at only 51-57 decibels, you can easily hold a conversation

and enjoy TV. Each A/C unit only draws 10.4 Amps on high.

2 A/C's easily run on 30 Amp service

3 A/C's easily run on 50 Amp service



Coleman Mach Q (Quiet) Air Conditioner decibel test. Used "Decibel X" app on iPhone XR placed on bed directly below AC unit.



## INDIVIDUALLY CONTROLLED

40

Have it your way! All three A/C units are individually controlled offering an infinite combination of settings for maximum comfort and convenience.

## 42,000 BTU FURNACE



42,000 BTUs of forced air heat runs through flex ducts connected to formed ducts in the floor. Our heating ducts are designed to be as short as possible to minimize heat loss experienced in long duct runs and maximize comfort throughout the coach.

There are also dedicated heat vents into the basement and underbelly to keep the tanks and your gear cozy warm in the cooler seasons.

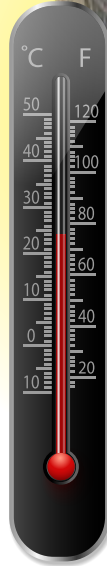

**42,000 BTU  
FURNACE**

**Combined  
47,000 BTU  
Of Heating Power**

## ELECTRIC FIREPLACE



**5,000 BTU  
FIREPLACE**



For the spring and fall days when the temperature does not justify firing up the furnace, the 5,000 BTU fireplace takes the chill out of the room without using LP. Fully adjustable, you can also enjoy the ambiance of the fireplace without heating up the room.

**NO CARPET ZONE**



**PET FRIENDLY EASY CLEAN  
ALLERGEN FREE**

You spoke,  
we listened.  
Vinyl flooring  
throughout  
(No Carpet)



## ALUMINUM FRAMED AND INSULATED FLOOR WITH SEAMLESS 5/8"



**Truboard** DECKING

Superior floor construction begins with a lightweight rigid aluminum frame that is insulated with fiberglass and a reflective foil barrier, then a seamless sheet of 5/8"

**Truboard** is secured on top and the bottom wrapped in a durable woven poly stranded material.



**Truboard**

CARRIES A 25 YEAR  
LIMITED WARRANTY

# FLUSH FLOOR KITCHEN SLIDE

45



No more raised slideroom floor in the kitchen to stub your toes on.

No more awkward footing or leaning way over to prepare your food.



Brand X's raised floor kitchen slide

## NO FLOOR VENTS - MAIN FLOOR

46

Floor vents are an eye-sore, foot-sore and a catch-all for dirt and trash. Our vents are mounted out of sight and off the main floor where they won't catch your bare foot in the dark by surprise.



**NO FLOOR VENTS**  
ON MAIN LEVEL

**ATRIUM**  
W I N D O W S

OVERSIZED WINDOWS  
MORE LIGHT, MORE FRESH AIR.

TINTED, TEMPERED  
FOR PROTECTION

**SAFETY**  
GLASS

ATRIUM  
WINDOWS



Alliance has bigger windows and more of them than anyone else. Enjoy a High Definition view of your surroundings.



## OPTIONAL THREE SEASON PATIO DOOR IN PLACE OF PULL DOWN SCREEN



Between the garage and ramp patio is our three season patio door that keeps the bugs out and the climate controlled air in. Built in screens also allow you to enjoy the fresh outdoors. The door folds neatly out of the way for loading the garage

## CROSS VENTILATION

49



Get more fresh air inside! Bedroom and living areas have strategically placed Atrium windows that open wide to create excellent cross ventilation in the living area and bedroom.

## MCD NIGHT SHADES

50

Whether you want to block out the bright light of day or have some privacy in the night hours, trust MCD roller shades for quality and ease of operation.



## MAXxFAN

51



The kitchen and bath are both equipped with MaxxFan roof vents standard. These high powered fans move air at a high rate of 900 cubic feet per minute and will close down at the first sign of rain with the built in rain sensor.

# KENSINGTON COLLECTION FURNITURE

Our Kensington furniture features a high quality polyurethane based fabric from the RICHLOOM Tough Collection. This is a non-bonded material that is resistant to the cracking and peeling often seen with inferior bonded fabrics. This fabric carries an extended RICHLOOM three year warranty.



## POWER RECLINE



Enjoy reclining comfort with the push of a button.





# HIDDEN ARM REST DRINK HOLDERS



Kensington furniture does not sacrifice style for convenience. Drink holders are there when you need them and stylishly concealed when you don't



# 110V AND USB CONVENIENCE POWER CENTER



Power your laptop and charge your phone while relaxing in style on the Kensington sofa.



56

## SOFT CLOSE CABINET DOORS

Not only do hidden soft close hinges look great, they are very functional. Soft close hinges prevent slamming which can weaken door joints and pull screws loose from the stiles. Soft close hinges close tightly in conjunction with magnetic latches and they stay closed in transit keeping your gear in the cabinet where it belongs.



## SOFT CLOSE DRAWER GLIDES

57

A residential luxury worth having. Similar to cabinet doors, slammed drawers weaken over time and can come apart unexpectedly.



## REINFORCED DRAWER BOTTOMS

58



90  
POUNDS

We use heavy duty ball bearing drawer glides, and as an added measure of quality and strength, we reinforce to bottom of every drawer preventing the silverware from ending up in the next drawer down. We put 90 pounds of exercise weights in a drawer to demonstrate our durability. (Don't try this in competitor's flimsy drawers.)

# INNOVATIVE SPACE SAVING AND STORAGE SOLUTIONS

## Flip Up Island Table >

Isle space by day and table by meal time! Haulers are limited on living space and the flip up island table makes the most of the available space enhancing your experience.



## Shoe Storage >

Under step shoe storage. As you walk in the door, what better place to take your shoes off and have a place to stash them out of the way yet handy for when your ready to go back outside again.



## RESIDENTIAL MICROWAVE

Our over-the-range microwave is a residential appliance with large capacity and high wattage.



- Convection
- Auto-cook settings
- Multi power levels
- Express cook
- Energy saving Eco mode
- Two speed exhaust fan
- Removable rack
- Task light
- 12.4" glass turntable
- Safety features

## BUILT-IN RANGE & OVEN

12 Volt ignition makes this built in stove and cook top a boondocking enthusiast dream. All the capacity to cook a Thanks giving dinner while offering additional countertop space with a glass flip top when the burners are not in use.

Three burners are sure to provide flexibility to cook any meal.

Last but not least there is a storage pull out drawer below the oven for cookware and larger items.

Stainless steel construction for long lasting functionality and beauty complementing the other appliances in the kitchen area.



## STAINLESS STEEL FARM SINK



This customer driven feature is sure to please anyone using the kitchen. The residential sized kitchen sink makes it easy to clean even the biggest pots and pans. A convenient roll out slotted drying rack is included. The perimeter of the sink features an integrated LED light strip that also lights up the cabinet below.



## 17 CU. FT. 12 VOLT RV REFRIGERATOR



Part of the Masters of 12 Volt package and engineered specifically for RVing this massive refrigerator is the key to longer boondocking. Faster cooling and efficient operation on renewable 12 volt energy from the lithium iron battery and charged by 640 watt solar panels. Boondock longer!



## MOTION LIGHTING

Motion lighting where you have your hands full and can't easily reach a switch.

## LIVING ROOM ULTRA HD TV



Living rooms feature name brand 4K Ultra HD TVs for the best entertainment experience.

## 12 VOLT GARAGE & BEDROOM TVS



Enjoy off grid entertainment anywhere with 12 volt TVs in the garage and bedroom. The garage TV includes a drop and swivel mount for optimum viewing.

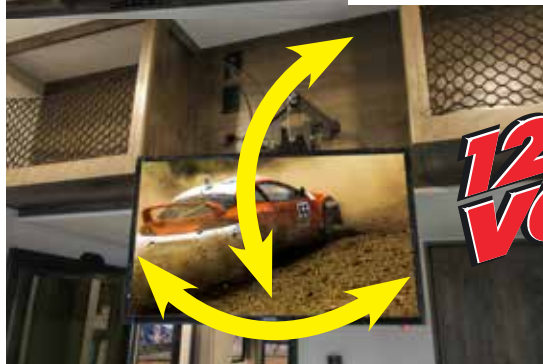

## TV HOOKUP

At Alliance we have made the TV hookup experience simple and easy to use.

ALLTV is designed to bring satellite, cable and antenna connections to all the TV locations throughout your RV.



# JBL AUDIOTAINMENT SYSTEM



AM/FM, USB, Bluetooth Audiotainment system brings the best of modern entertainment to your fingertips. Hyper bass subwoofer and JBL speakers create BIG sound in a small space. For even more control, download the JBL app to control your system from a smart phone or tablet, answer phone calls, stream media from your phone to the TV, play media from a flash drive and more.



## USB CHARGING PORTS

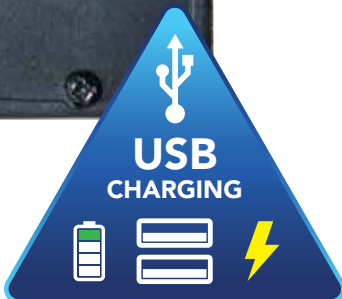

With all the cell phones, tablets, earbuds, GPS units, and other electronic devices you can't have too many USB charge ports. 2x2x2 is a phrase you might hear in an Alliance RV referring to 2 USBs in the end tables, 2 USBs in the theater seats and 2 USBs in the bedroom nightstands.

Remember your ABCs  
Always Be Charging

# SMART WIRE

COLOR/NUMBER CODED



Ever wonder which wires run where? We are not afraid to show you what is behind the covers. In fact, we are proud of the extra effort put into keeping the wiring and plumbing neat and organized. This extra effort helps prevent problems and saves hours on diagnosing trouble down the way. Color coded and numbered wiring makes for quicker repairs and simplifies do-it-yourself projects.

Most RV wiring looks like spaghetti. All the wires look the same, no idea where they run and all tangled up in a jumbled mess.



## CONVENIENTLY LOCATED AND CLEARLY MARKED BREAKER/FUSE BOX



We position our breaker/fuse boxes where you can get to them easily and clearly mark every breaker and fuse.

We also provide a smart wire code guide so you can easily identify and trace wiring back to the source.





# CONTROL CENTER



Generally located near the entrance, our control center is easy to read and use. Every switch is marked clearly and organized logically.

# INDIVIDUALLY SWITCHED SLIDE OUTS



No more waiting for all the slides to run out in sequence to get to the one you really want. Say you're at a rest stop and you just want to run out one slide so you can get to the bedroom, bathroom, or refrigerator. No problem, simply run that slide out and only as far as you need.

# DIMMABLE LED FLUSH CAN LIGHTING

RV LED lighting is very bright and can be blinding. Alliance offers a twenty first century solution. A dimmer switch gives you control of your lighting in the living area and bedroom. It is a simple solution that most RV makers neglect to address.

**SMART LED DIMMER**



**PERFECT LIGHTING:**  
DAY OR NIGHT, TASK OR MOOD  
(REMEMBERS LAST SETTING)

Our LED ceiling lights are a flush mount can style like what you see in todays homes.



# LED ACCENT LIGHTING



Alliance features LED accent lighting built into the crown molding, kitchen sink, select cabinets, and even the bathroom mirror. Create an appealing indirect glow that looks great day or night. Pendants with heavy glass globes swing and rip out of the ceiling when the trailer makes an abrupt stop. Our lightweight pendant lights don't have the mass and inertia to get moving and rip out at abrupt stops.

# THE MASTERS of 12 VOLT

BOONDOCK LONGER  
Than ever before!

## PACKAGE INCLUDES:

- 100 Amp Hour Lithium Iron Phosphate Battery •
- Battery Monitor System •
- 40 Amp Charge Controller •
- 2x 320 Watt Solar Panels •
- 17 Cubic Foot 12 Volt Refrigerator •

*In addition to more 12 volt systems than similar Haulers on the market*

77



Equivalent of two traditional RV batteries and 1/5 the weight!



78

Know exactly what is really going on with real time monitoring of power usage and battery condition.

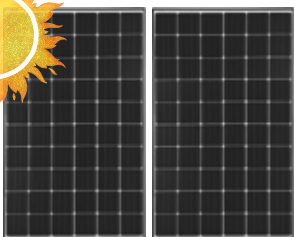
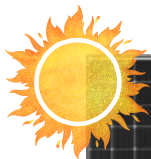

640 watts of high efficiency, pure power generation.

79

Testing shows that this combination of components outperforms traditional solar packages hands down.



17 Cubic Feet



12 VOLT

## MORE 12 VOLT SYSTEMS

FOR A SUPERIOR BOONDOCKING EXPERIENCE!

- ✓ 12V Air Compressor
- ✓ 12V Fuel Tank Pump
- ✓ 12V Power Recliners
- ✓ 12V USB Charge Ports
- ✓ 12V Garage TV
- ✓ 12V Bedroom TV
- ✓ 12V Stereo System
- ✓ 12V Antenna
- ✓ 12V LED Lighting
- ✓ 12V Garage Bed Lift
- ✓ 12V Ramp Gate Lock
- ✓ 12V Slide Outs
- ✓ 12V Landing Gear
- ✓ 12V Furnace 12V/Gas
- ✓ 12V Water Pump



# WEATHER RESISTANT RAMP PATIO

Ramp doors are not just for loading anymore.

Our ramp doors are weather resistant and engineered to give you 60 square feet of elevated patio space attached to the garage.

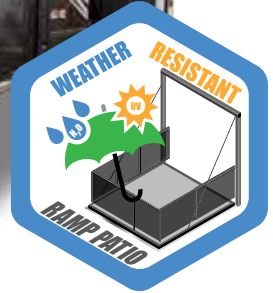

## INSULATED



## GARAGE FLOOR

FOR MAXIMUM SEASONAL COMFORT



Insulating the garage floor helps keep the garage area comfortable in cold and hot conditions while also reducing noise making the garage area quieter and more enjoyable for everyone.



## L-TRACK

D rings are never where you need them for securing items of varying size and shape. L-Track offers infinite arrangements of anchor points to tie down almost anything.



83

## ON-BOARD COMPRESSOR



Tires and inflatables are topped of with ease using the built-in 12 Volt air compressor with hose connections on both sides of the garage.



84

## FUEL TANKS

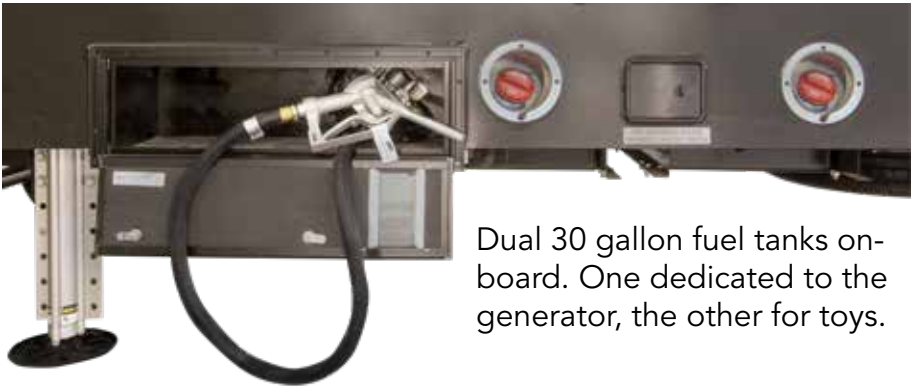

Dual 30 gallon fuel tanks on-board. One dedicated to the generator, the other for toys.

Convenient gas station pump style fill hose and nozzle for clean and safe filling of your toys. The fill hose compartment is lockable for security and vented for safety.

85

## ROOF ACCESS LADDER

Easily and safely access your roof for maintenance without getting out a stepladder. The roof access ladder folds up and locks neatly against the sidewall for travel.



## KING BED STANDARD

Sleep like Royalty on our standard King size Serta mattress. Walk around the bed to make it easily and get in and out on both sides like you do at home in your bedroom.

(Optional Queen bed - available)



## OVERHEAD BED WINDOW



Many RV bedrooms are dark and feel confined. We install a window above the headboard to let in light and open the room up to a bright, spacious feel. You can even open the window on those cool summer nights.

## PADDED HEADBOARD

Watching TV or reading a good book, the padded headboard is a comfortable alternative to hard wooden headboards that serve no purpose. Just another example of Alliance listening to customers and implementing the feedback.

## HAPPI JACK

Valor garages feature Happi Jack bunks and sofas that elevate to make room for cargo or lower for seating and sleeping



## UNDER-BED STORAGE

Huge under-bed storage compartment with gas struts to assist in opening 18.75 cubic feet of finished storage space. Perfect for the folding dinette chairs, extra blankets, sleeping bags or totes full of gear you want access to without going outside to the basement compartments.



## DEEP BEDROOM DRESSERS



When it comes to storage, size does matter. Many RV dressers have lots of drawers but they are so shallow you can't fit much of anything in them. Alliance dresser drawers are deep front to back and top to bottom like a residential dresser. You can keep real adult size clothes in these drawers.



All the dresser drawers are mounted on heavy duty ball bearing drawer glides with soft close and are reinforced on the underside for maximum usability.

## DRESSER TOP HIDDEN STORAGE



**HIDDEN STORAGE**



Hidden in the dresser, is a place to keep your jewelry, watch, wallet, or anything you want out of sight but still handy. The dresser top is only half lid, the other half is stationary so you can keep some things on top and still access the hidden compartment.



## PERSONAL READING LIGHTS



Above the headboard are ceiling mounted, LED reading lights. Each light is individually pushbutton switched and easy to reach.

## RUSTIC SLIDING BARN DOORS



In an RV, every square inch of floorspace counts. Sliding barn doors offer the privacy of a solid swinging door, taking up half the floorspace of a pocket door since there isn't a second wall to surround it and no swinging door to get in the way... It is the best of both worlds and they look great. Heavy duty rolling hardware and a steel track make for smooth operation while tie-backs keep the door in place during transit.



# HUGE CLOSETS



Could there be such a thing as too much closet? Face it, we all have lots of stuff and most RVs simply do not provide much closet space. Valor fifth wheels have some of the biggest closets on the market with hanging storage, shelf storage and cubbies.

\*Closets Vary by Model.



Left Side

Center

Right Side

# WASHER DRYER PREP



We make it easy to add a washer and dryer with dedicated locations pre-engineered to accept the washer and dryer with 110 volt outlets, color coded hot and cold water hookups, drain connection and outside vent location all ready for a quick and easy upgrade.

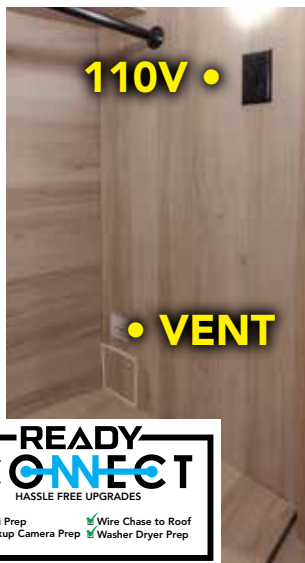

# LED BACKLIT MIRRORS

97

Often seen in expensive hotels and luxurious residential homes, backlit mirrors are a great night light or just a pleasing indirect accent light to set your bathroom apart from the rest.



98

# EPOXY COUNTER TOPS THROUGHOUT



Where weight is a consideration, epoxy poured tops are a fantastic alternative to solid surface or pressed tops. A lightweight substrate in a variety of colors and patterns is coated in an industrial epoxy with a high gloss luxurious finish. Common in restaurants and bars, epoxy tops are extremely durable and easy to clean with a soft cloth and mild detergent..



# 48" RESIDENTIAL SHOWERS



No more tiny Neo-Angle showers! Alliance residential showers are huge and packed with great features. From the ground up, the reinforced fiberglass base is solid and does not flex under your feet breaking the seal around the drain. The shower surround is seamless material that is mold and stain resistant. Easy clean: wipe down with

a soft cloth and mild detergent. The shower head is mounted high enough for the tall folks to enjoy without stooping down.



## TRIPLE GLASS SLIDING SHOWER DOOR



This space saving design allows you to open the shower up wide for easy and safe entry without big swinging doors getting in the way and dripping all over the floor. A simple travel lock keeps the doors secure while on the road. The anodized aluminum frame will not rust or corrode and keep looking great for years to come.



# SOFT CLOSE PORCELAIN TOILET

101

The Dometic RV toilet may actually be better than the common residential bowl. With its powerful bowl-clearing flush, modern rimless design, full-size ceramic bowl and home-like seat height, the Dometic 310 toilet provides unmatched performance. The hygienic hands-free foot pedal with adjustable water level simultaneously help conserve water while providing a robust flush. The full-size ceramic bowl and seat height deliver comfort while living mobile. The watertight flush ball system maintains water in the bowl at all times, meaning any unpleasant odors are kept in the waste holding tank. Perhaps best of all, with a **soft close seat and lid** there's no accidental slamming shut in the middle of the night to wake anyone up. The seat is also enameled for easy cleaning and solid in design without the honeycomb under most RV toilets that collects filth and is hard to clean.



# PREPPED FOR THE MOST COMMON UPGRADES

**BONUS**

We surveyed thousands of RV owners to learn the good, bad, and ugly of owners' experiences and a common issue was the difficulty of upgrading later. Not everyone wants to buy every option available when they buy a new RV and needs can change. Upgrades become a big hassle if not properly prepped. We identified the eight most common upgrades after the sale and made them as easy as possible to add later.

## READY CONNECT

HASSLE FREE UPGRADES

- ✓ WiFi Prep
- ✓ Backup Camera Prep
- ✓ Wire Chase to Roof
- ✓ Washer Dryer Prep



WiFi Prep



**ROOF ACCESS**

Wire Chase  
to Roof Access  
(Roof to Storage Bay)



Backup Camera Prep



Washer / Dryer Prep